



ULTRAHEAT

Compact 4 & 6

Panel Radiators Pricelist

MARCH 2023 GBP

Durable and versatile, Compact 4 and Compact 6 radiators offer a range of cost-effective, rapid heating solutions for homes and working environments.

10-YEAR WARRANTY

Each radiator is individually tested and supplied complete with a 10-year warranty against any defects as a result of a manufacturing or a material fault.

All radiators are pressure tested at 13 Bars before despatch to guarantee a working pressure of 10 Bars.

MATERIAL

Conforms to BSI449, Part 1, products are manufactured from 1.20mm cold rolled steel.

INSTALLATION

Each radiator is supplied with concealed brackets, 1/2 self-jointing air vents and plugs in protective, heavy duty packaging.

QUALITY

All radiators are manufactured under BS EN ISO 9001:2015.



IN-STOCK RANGE: COLOUR CODING

 Standard Compact 4 (While stocks last) 200mm and 300mm vertical radiators with waterways that run horizontally. (tappings of the normal Compact 4 radiators turned 90° to the side).

 Standard Compact 4 Radiators with 4 taps.

FACTORY ORDER

 Compact 4 & 6 Non-stock items. Factory order only.

COMPACT 4 HF
Double Panel, Single Convecter

HF

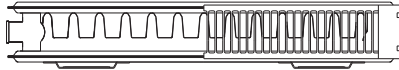

ALL PRICES EX. VAT

Width		HF	Height 300mm (11.8")			HF	Height 400mm (15.7")			HF	Height 500mm (19.7")			HF	Height 600mm (23.6")		
mm	inch	Code H+Type+W	Output ΔT50°C BTU	Watts	Price £/Each	Code H+Type+W	Output ΔT50°C BTU	Watts	Price £/Each	Code H+Type+W	Output ΔT50°C BTU	Watts	Price £/Each	Code H+Type+W	Output ΔT50°C BTU	Watts	Price £/Each
300	11.8	-	-	-	-	-	-	-	-	-	-	-	-	-	-	-	-
400	15.7	3HF400	1120	328	£167.60	4HF400	1428	418	£173.45	5HF400	1718	503	£190.48	6HF400	1991	583	£223.36
500	19.7	3HF500	1401	410	£190.45	4HF500	1785	523	£195.18	5HF500	2147	629	£213.52	6HF500	2489	729	£245.35
600	23.6	3HF600	1681	492	£234.63	4HF600	2142	627	£226.79	5HF600	2576	754	£256.07	6HF600	2986	874	£286.34
700	27.6	3HF700	1961	574	£265.15	4HF700	2499	732	£262.54	5HF700	3006	880	£298.86	6HF700	3484	1020	£334.57
800	31.5	3HF800	2241	656	£297.97	4HF800	2856	836	£298.48	5HF800	3435	1006	£339.56	6HF800	3982	1166	£382.99
900	35.4	3HF900	2521	738	£332.44	4HF900	3213	941	£334.22	5HF900	3865	1131	£382.23	6HF900	4479	1311	£429.49
1000	39.4	3HF1000	2801	820	£372.46	4HF1000	3570	1045	£370.47	5HF1000	4294	1257	£425.02	6HF1000	4977	1457	£479.62
1100	43.3	3HF1100	3081	902	£409.67	4HF1100	3927	1150	£405.74	5HF1100	4723	1383	£468.22	6HF1100	5475	1603	£527.05
1200	47.2	3HF1200	3361	984	£450.96	4HF1200	4284	1254	£441.62	5HF1200	5153	1508	£513.83	6HF1200	5973	1748	£574.48
1300	51.2	-	-	-	-	4HF1300	4641	1359	£479.43	5HF1300	5582	1634	£565.95	6HF1300	6470	1894	£670.67
1400	55.1	3HF1400	3922	1148	£530.89	4HF1400	4998	1463	£517.17	5HF1400	6011	1760	£618.05	6HF1400	6968	2040	£679.69
1500	59.1	-	-	-	-	4HF1500	5355	1568	£564.46	5HF1500	6441	1886	£662.50	6HF1500	7466	2186	£773.80
1600	63	3HF1600	4482	1312	£612.20	4HF1600	5712	1672	£584.82	5HF1600	6870	2011	£706.99	6HF1600	7963	2331	£824.85
1800	70.9	3HF1800	5042	1476	£694.86	4HF1800	6425	1881	£660.36	5HF1800	7729	2263	£794.66	6HF1800	8959	2623	£928.97
2000	78.7	-	-	-	-	4HF2000	7139	2090	£756.06	5HF2000	8588	2514	£924.85	6HF2000	9954	2914	£1,112.56
2200	86.6	-	-	-	-	4HF2200	7853	2299	£867.51	5HF2200	9447	2765	£1,047.99	6HF2200	10950	3205	£1,270.82
2400	94.5	-	-	-	-	4HF2400	8567	2508	£1,097.39	5HF2400	10305	3017	£1,268.93	6HF2400	11945	3497	£1,465.10

Width		HF	Height 700mm (27.6")			HF	Height 900mm (35.4")			HF	Height 1800mm (70.86")			HF	Height 2000mm (78.74")		
mm	inch	Code H+Type+W	Output ΔT50°C BTU	Watts	Price £/Each	Code H+Type+W	Output ΔT50°C BTU	Watts	Price £/Each	Code H+Type+W	Output ΔT50°C BTU	Watts	Price £/Each	Code H+Type+W	Output ΔT50°C BTU	Watts	Price £/Each
400	15.7	7HF400	2250	659	£282.65	9HF400	2730	800	£416.47	18VHF400	5459	1600	£1,033.53	20VHF400	6066	1778	£1,122.04
500	19.7	7HF500	2813	824	£341.36	9HF500	3412	1000	£462.17	18VHF500	6824	2000	£1,088.69	20VHF500	7582	2222	£1,190.96
600	23.6	7HF600	3376	988	£409.61	9HF600	4091	1199	£554.35	18VHF600	8182	2398	£1,181.58	20VHF600	9091	2664	£1,281.85
700	27.6	7HF700	3938	1153	£477.84	9HF700	4773	1399	£647.15	-	-	-	-	-	-	-	-
800	31.5	7HF800	4501	1318	£546.41	9HF800	5459	1600	£897.38	-	-	-	-	-	-	-	-
900	35.4	7HF900	5064	1482	£614.13	-	-	-	-	-	-	-	-	-	-	-	-
1000	39.4	7HF1000	5626	1647	£696.20	-	-	-	-	-	-	-	-	-	-	-	-
1100	43.3	7HF1100	6189	1812	£750.65	-	-	-	-	-	-	-	-	-	-	-	-
1200	47.2	7HF1200	6751	1976	£818.67	-	-	-	-	-	-	-	-	-	-	-	-
1300	51.2	7HF1300	7314	2141	£922.73	-	-	-	-	-	-	-	-	-	-	-	-
1400	55.1	7HF1400	7877	2306	£1,051.31	-	-	-	-	-	-	-	-	-	-	-	-
1500	59.1	-	-	-	-	-	-	-	-	-	-	-	-	-	-	-	-
1600	63	7HF1600	9002	2635	£1,179.60	-	-	-	-	-	-	-	-	-	-	-	-
1800	70.9	7HF1800	10127	2965	£1,363.92	-	-	-	-	-	-	-	-	-	-	-	-

White RAL 9016 and Anthracite RAL 7016

Compact 4 radiators are supplied in White RAL 9016 with an option for factory-baked Anthracite RAL 7016 grey in the models and sizes shown right.

Width		Finish RAL Colour	HF-A	Height 600mm (23.6")		
mm	inch		Code H+Type+W	Output ΔT50°C BTU	Watts	Price £/Each
600	23.6	Anthracite RAL 7016	6HF600A	2986	874	£400.87
800	31.5	Anthracite RAL 7016	6HF800A	3982	1166	£532.35
1000	39.4	Anthracite RAL 7016	6HF1000A	4977	1457	£657.08
1200	47.2	Anthracite RAL 7016	6HF1200A	5973	1748	£781.28
1400	55.1	Anthracite RAL 7016	6HF1400A	6968	2040	£917.57
1600	63	Anthracite RAL 7016	6HF1600A	7963	2331	£1,121.80



WALL & FLOOR BRACKETS

Wall Bracket Compatibility

Compact 4 Radiator	Radiator Height	Bracket Code	Quantity x 2 Pcs	Quantity x 3 Pcs
SF / HF DF / DS TS / QS	200mm	2CWB	Radiator Length	Radiator Length
	300mm	3CWB		
	400mm	4CWB		
	500mm	5CWB		
	600mm	6CWB		
	700mm	7CWB		
900mm	9CWB	400mm to 1600mm	1800mm to 2400mm	

Floor Bracket Compatibility

Bracket Code	SF		HF		DF/DS		TS		QS
	Radiator Height		Radiator Height		Radiator Height		Radiator Height		Radiator Height
	300mm to 400mm	500mm to 900mm	300mm to 400mm	500mm to 900mm	200mm to 400mm	500mm to 900mm	200mm to 400mm	500mm to 900mm	200mm to 300mm
DFBSw					✓	✓	✓	✓	✓
DFBLw					✓	✓	✓	✓	✓
SFBW	✓		✓		✓		✓		
UFBSw		✓		✓		✓		✓	
UFBLw		✓		✓		✓		✓	
Quantity	Radiator Length		Radiator Length		Radiator Length		Radiator Length		Radiator Length
x 2 Pcs	400mm to 1600mm		All Lengths	300mm to 1600mm	All Lengths	300mm to 1600mm	All Lengths	300mm to 1600mm	800mm to 1600mm
x 3 Pcs	1800mm to 3000mm			1800mm to 2400mm		1800mm to 3000mm		1800mm to 2700mm	1800mm to 2400mm

Concealed Wall Brackets

ALL PRICES EX. VAT



2CWB

Concealed Wall Brackets For 200mm High Horizontal Panel Radiators

Nickel N **£4.49**

3CWB

Concealed Wall Brackets For 300mm High Horizontal Panel Radiators

Nickel N **£4.67**

4CWB

Concealed Wall Brackets For 400mm High Horizontal Panel Radiators

Nickel N **£4.93**

5CWB

Concealed Wall Brackets For 500mm High Horizontal Panel Radiators

Nickel N **£5.64**

6CWB

Concealed Wall Brackets For 600mm High Horizontal Panel Radiators

Nickel N **£6.53**

7CWB

Concealed Wall Brackets For 700mm High Horizontal Panel Radiators

Nickel N **£7.40**

9CWB

Concealed Wall Brackets for 900mm High Horizontal & 1200, 1400, 1600mm for Vertical Panel Radiators

Nickel N **£8.81**

12CWB

Concealed Wall Brackets For 1800 - 2000mm High Vertical Panel Radiators

Nickel N **£9.25**

Anti-Lift Brackets

Floor Brackets

ALL PRICES EX. VAT



600ALCB2-Z

For 600mm high radiators.

Nickel (Pair) N **£64.80**

600ALCB3-Z

For 600mm high radiators.

Nickel (3 pcs) N **£97.30**

700ALCB2-Z

For 700mm high radiators.

Nickel (Pair) N **£73.40**

700ALCB3-Z

For 700mm high radiators.

Nickel (3 pcs) N **£110.20**

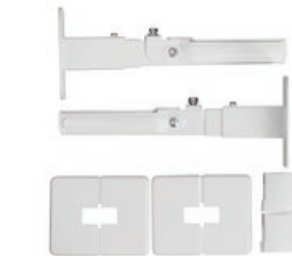

SFBW

Floor Bracket for Single Radiator.

White RAL 9016 W **£61.72**



DFBSw

Floor Bracket for Double Radiator. Short - 120mm to 170mm.

White RAL 9016 W **£64.38**

DFBLw

Floor Bracket for Double Radiator. Long - 240mm to 315mm.

White RAL 9016 W **£102.29**



UFBSw

Universal Floor Bracket. Short - 150mm to 200mm.

White RAL 9016 W **£43.43**

UFBLw

Universal Floor Bracket. Long - 262mm - 360mm.

White RAL 9016 W **£70.57**

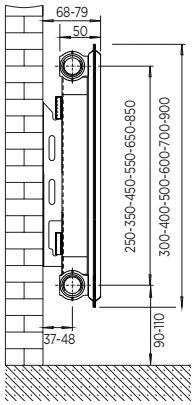

SF
Single Panel
Single Convactor

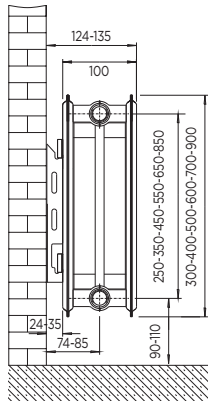

DF
Double Panel
Double Convactor

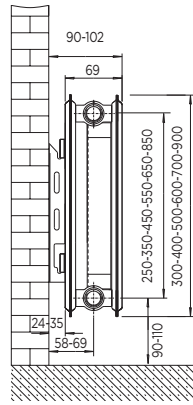

HF
Double Panel
Single Convactor

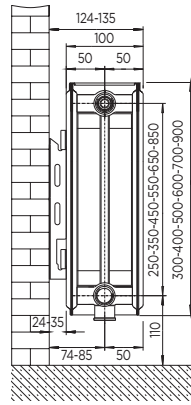

DS
Double Panel
Double Convactor

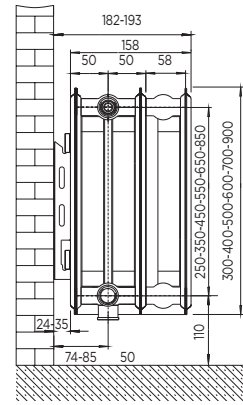

TS
Triple Panel
Triple Convactor

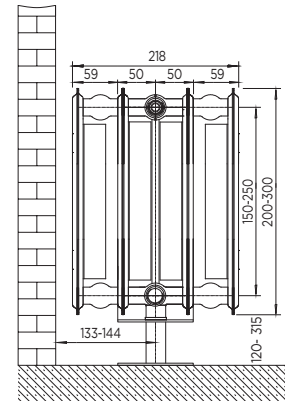

QS
Quadruple Panel
Single Convactor

Wall Brackets

HEIGHT	H	A	B
200mm	75	55	-
300mm	185	155	-
400mm	285	255	90
500mm	385	355	190
600mm	485	455	290
700mm	585	555	390
900mm	785	755	590

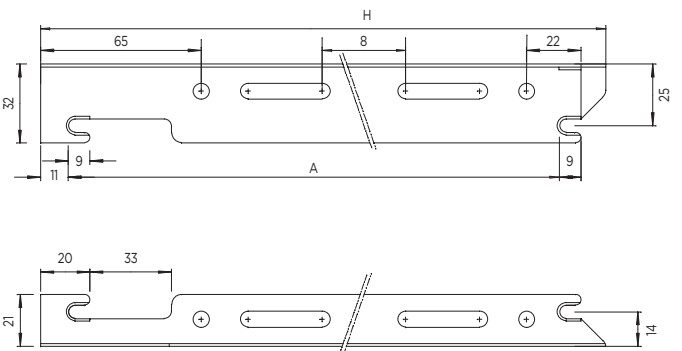
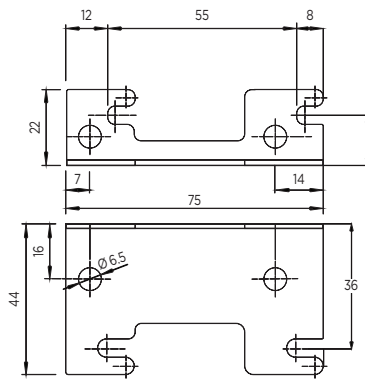

Bracket Positioning

LENGTH (mm)	A (mm)		B (mm)		SET OF LUGS
	SF	HF-DF-TS	SF	HF-DF-TS	
400	166	134	117	133	2
500	200	234	150	133	2
600	300	334	150	133	2
700	400	434	150	133	2
800	500	534	150	133	2
900	600	634	150	133	2
1000	700	734	150	133	2
1100	800	834	150	133	2
1200	900	934	150	133	2
1400	1100	1134	150	133	2
1600	1300	1334	150	133	2
1800	767	767	150	133	3
2000	867	867	150	133	3
2200	967	967	150	133	3
2400	1067	1067	150	133	3
2600	1167	1167	150	133	3
2700	1217	1217	150	133	3
2800	1267	1267	150	133	3
3000	1367	1367	150	133	3

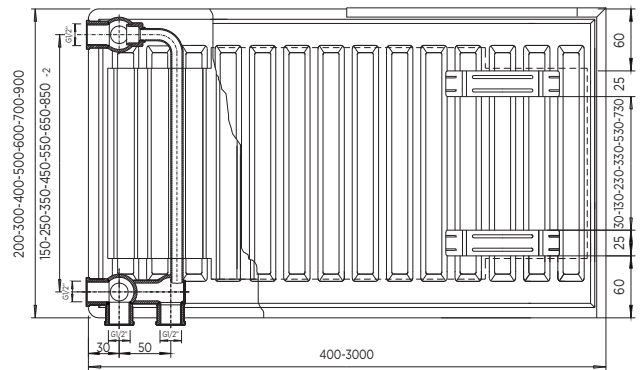
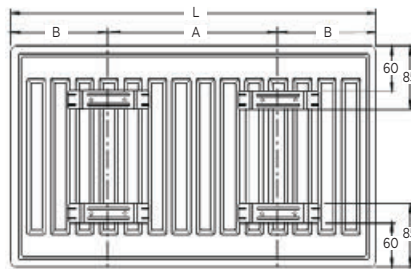

Water Content and Weight

per metre length

HEIGHT mm	Inch	SINGLE - SF		SINGLE PLUS - HF		DOUBLE - DF		TRIPLE - TS		QUADRUPLE - QS	
		Litre	Kg	Litre	Kg	Litre	Kg	Litre	Kg	Litre	Kg
200	7.8	-	-	-	-	2.72	10.86	4.05	16.01	5.40	30.15
300	11.8	2.60	8.97	3.50	14.13	3.50	16.05	5.20	23.63	8.10	45.20
400	15.7	2.73	11.65	4.27	18.54	4.27	21.16	6.39	31.33	-	-
500	19.7	2.87	14.33	5.03	22.98	5.03	26.31	7.59	38.99	-	-
600	23.6	3.00	17.01	5.80	27.40	5.80	31.43	8.78	46.59	-	-
700	27.6	3.30	19.39	6.43	31.25	6.43	35.98	9.69	53.84	-	-
900	35.4	3.90	24.87	7.70	42.72	7.70	46.85	11.50	69.74	-	-

DELTA FACTORS IN °C OTHER THAN ΔT50 AT 20°C ROOM TEMPERATURE			
15°C	4.9779	50°C	1.0000
20°C	3.3923	55°C	0.8807
25°C	2.5194	60°C	0.7842
30°C	1.9758	65°C	0.7049
35°C	1.6088	70°C	0.6386
40°C	1.3465	75°C	0.5824
45°C	1.1508	80°C	0.5344

Divide the heat outputs to ΔT50 by respective coefficient above to achieve the corrected heat outputs.

INSTALLATION GUIDE

For maximum efficiency, radiators should be fixed at no more or less than the measurements given on the drawings herein, from finished floor level.

We supply a bottom opposite end (BOE) connection pipe positioning guide for the manual valve, please allow 35mm to the centre of the pipe. For TRV valve allow 45mm to pipe centre. To prevent damage, it is strongly recommended that protective packaging is left on the radiator until installation is complete. Simply remove lug protectors and pre-cut tapping connection.

Finish: each radiator is degreased and electrostatically powder coated with epoxy polyester stove enamel, after an application of water based primer. Oven baked to provide a high gloss finish in white enamel (RAL 9016) or Anthracite (RAL 7016), the finished surface requires no further painting.

Water Treatment: on completion of the installation the system should be properly flushed and filled in accordance with the British Standard Code of Practice for the Treatment of Water in Domestic Hot Water Central Heating System BS7593.



Scan the QR code to receive a digital PDF or to request additional print copies.

IMPORTANT

Please read the following points carefully before installing your ULTRAHEAT radiator:

DO make sure that you have considered the design and layout of your central heating system as this will ensure satisfactory functioning of the system in general, and the radiators in particular.

DO vent your system properly. Leak and corrosion problems are usually due to excess air getting into the system.

DO ensure that the drain points are at the lowest points in the system.

DO make absolutely certain that the system is thoroughly flushed before it is commissioned. Rinse out all metal, flux and other foreign residues; the cause of pin-holing.

DO avoid over pumping the system, which causes negative pressure aeration, one of the most common causes of corrosion.

DO add an approved chemical inhibitor as an additional safeguard, but remember that it is no substitute for good installation practice.

DO observe the above basic guidance. Not only will you protect your warranty, but you will have years of trouble-free service from your radiator.

DON'T FORGET – the best radiators deserve the best installation practice.

ULTRAHEAT

Ultraheat is the heating division of Pitacs Limited

Bradbourne Point, Bradbourne Drive,
Tilbrook, Milton Keynes
Buckinghamshire, MK7 8AT
United Kingdom

T: +44 (0)1908 010333 F: +44 (0)1908 640017

E: heating-sales@pitacs.com

W: www.ultraheat.co.uk



5 056498 323546 >

UH-C4-PL(GBP)-MAR23