

ALL MEASUREMENTS ARE IN MILLIMETRES MANUFACTURED FROM MILD STEEL

4K14

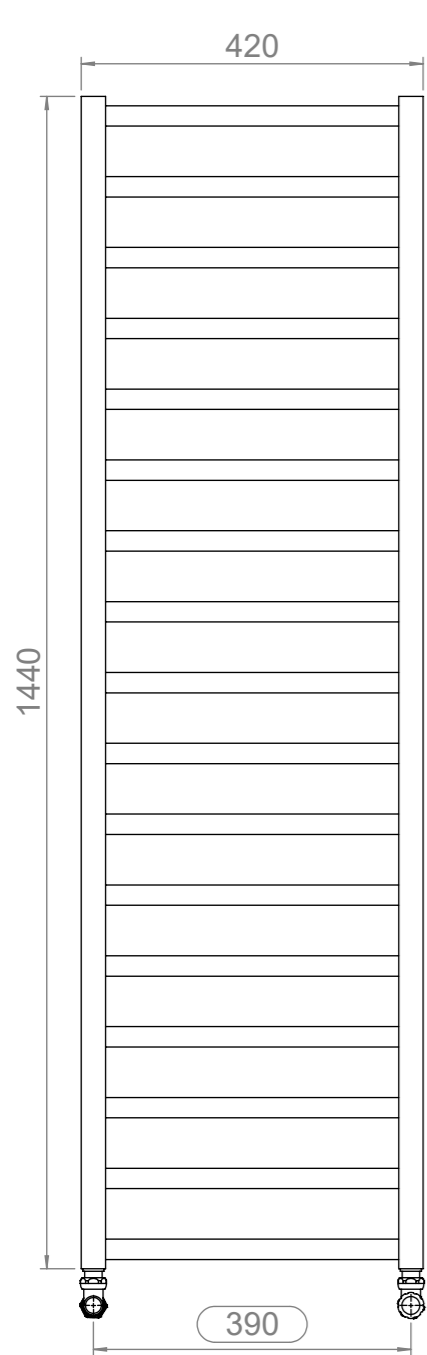

Front View

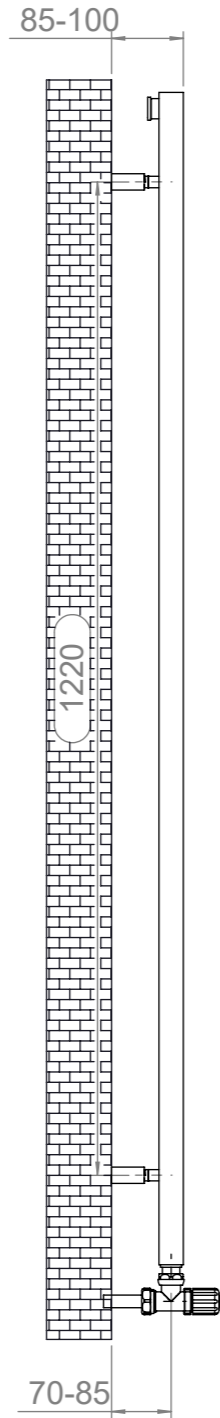

Side View

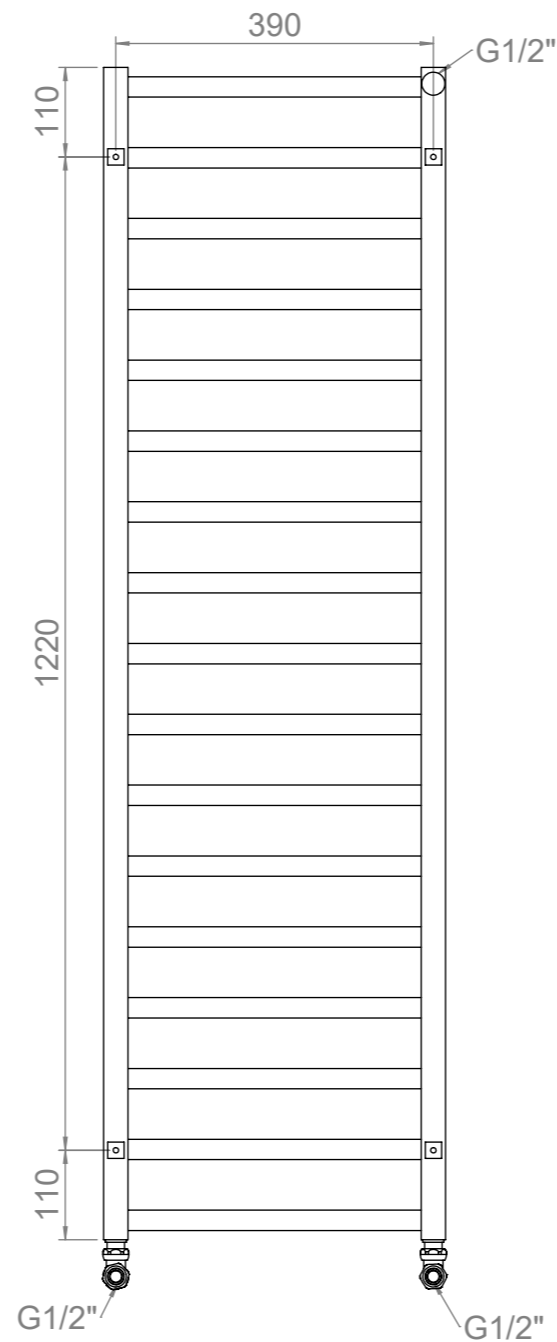



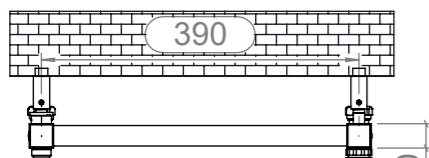
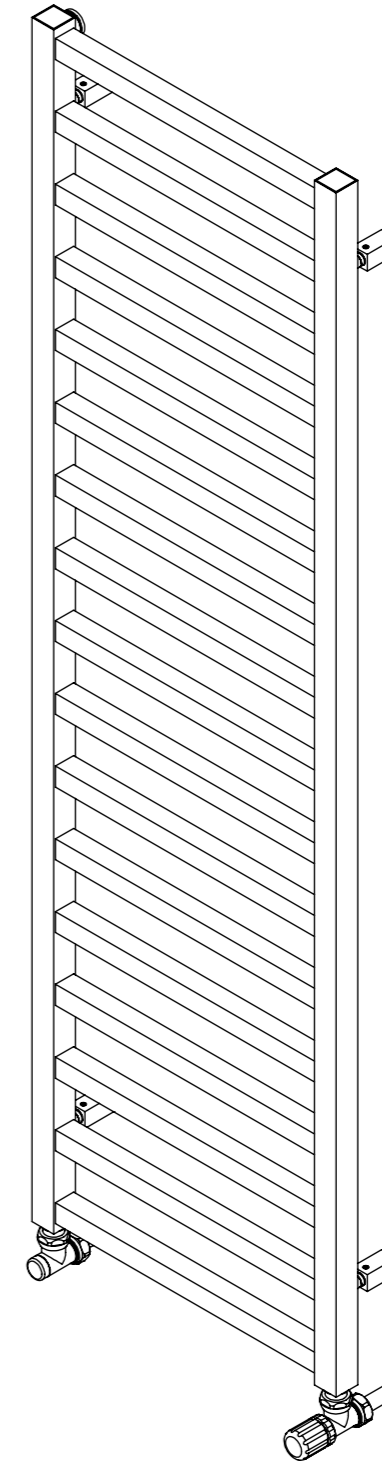

Back View



Top View

Installation Accessories:

-  x4
-  x4
-  x4
-  x4
-  x1

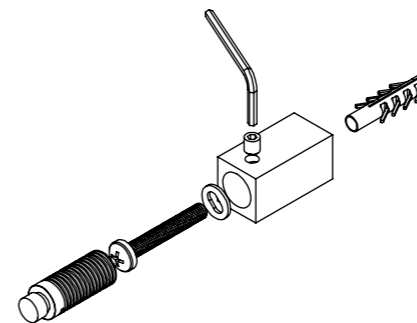

Fitting Position:

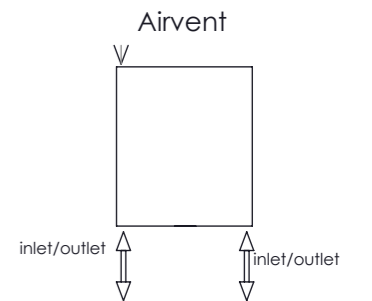

All Dimensions are in mm
 Max. Working Pressure: 10 Bar
 Max. Working Temperature: 95° C
 Inlet / Outlet : 1/2" BSP
 Fuel Type: H