

ALL MEASUREMENTS ARE IN MILLIMETRES MANUFACTURED FROM MILD STEEL

## 3K14

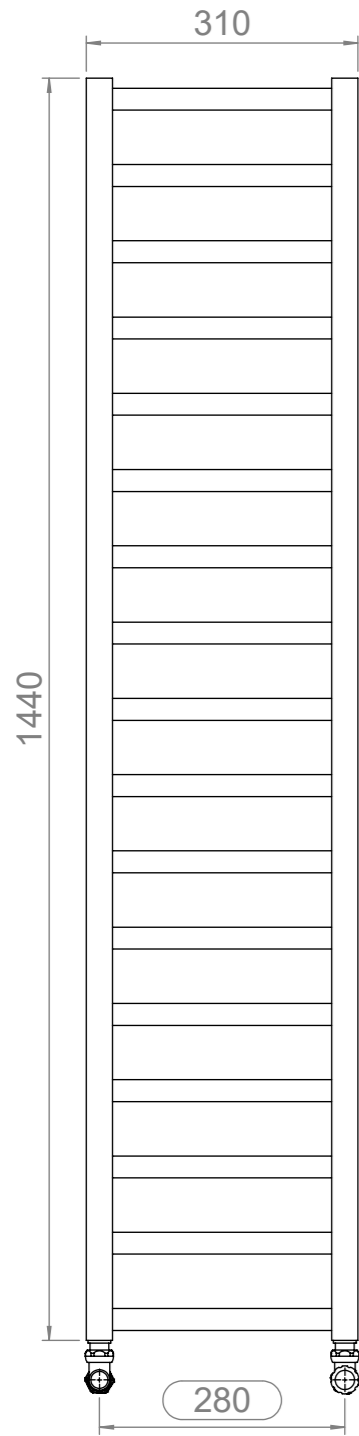

Front View

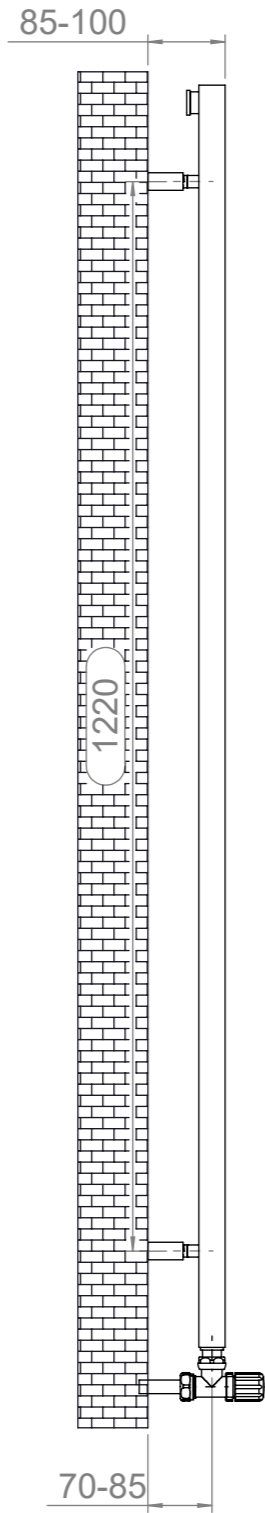

Side View

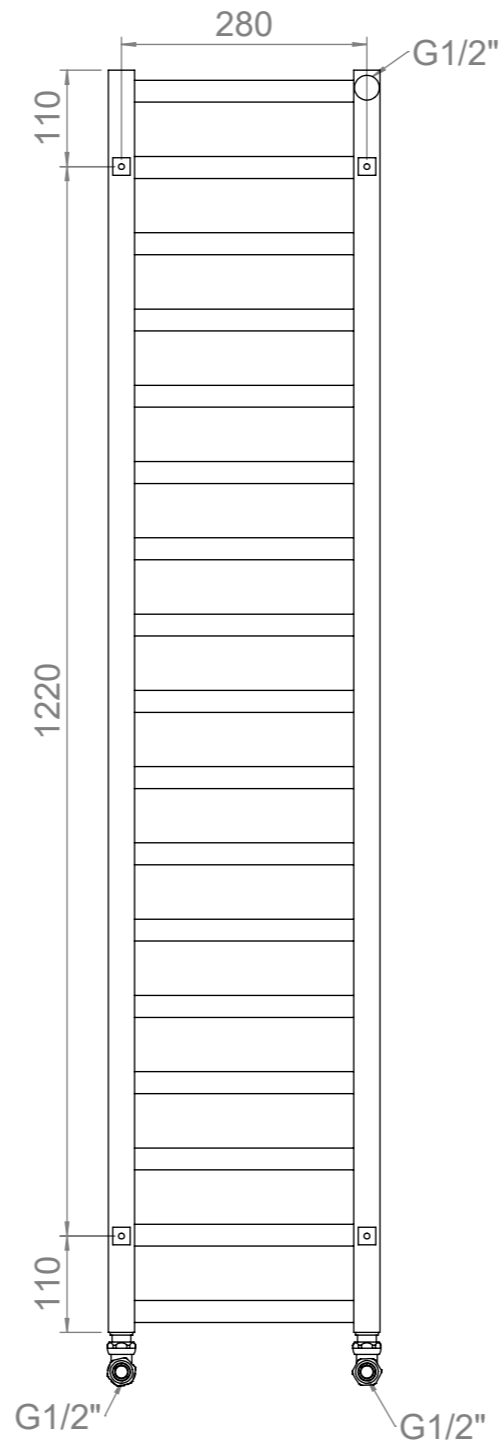



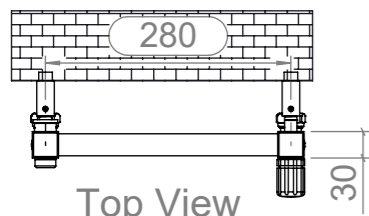
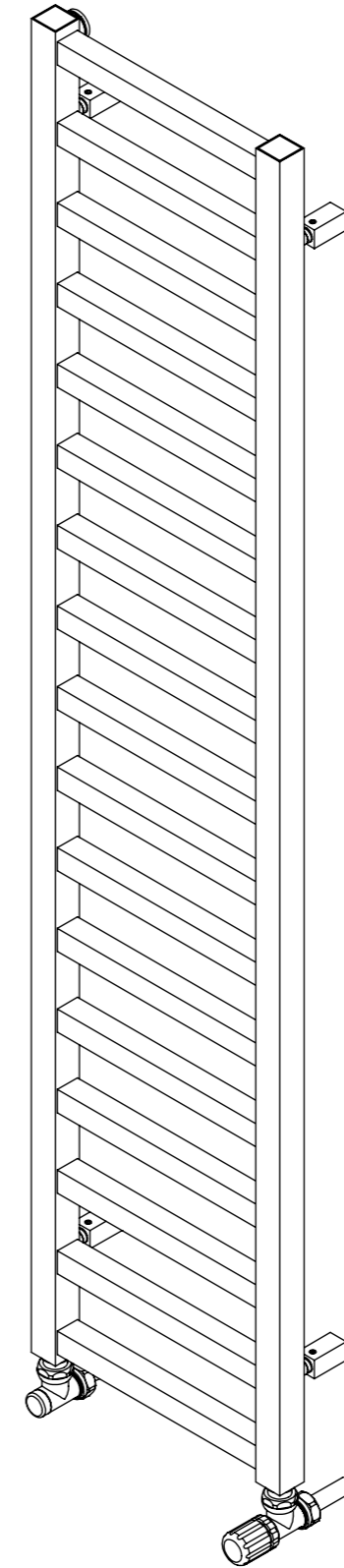

Back View

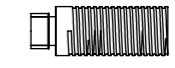
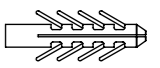

Top View

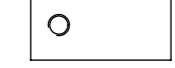
### Installation Accessories:

-  x4       x4
-  x4       x4
-  x4       x1

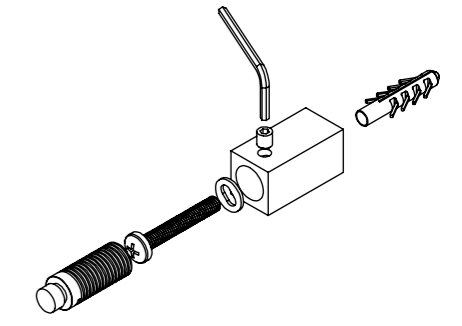

### Fitting Position:

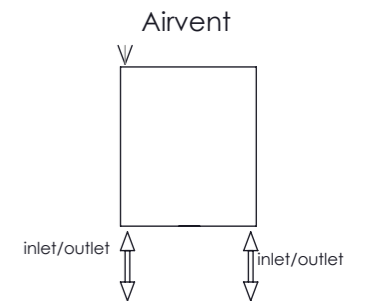

All Dimensions are in mm  
 Max. Working Pressure: 10 Bar  
 Max. Working Temperature: 95° C  
 Inlet / Outlet : 1/2" BSP  
 Fuel Type: H