

CHELMSFORD (4MA9)

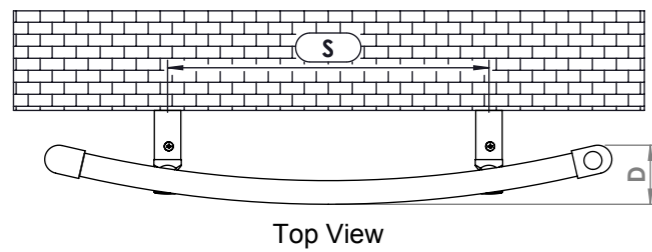

Plumbing Position: Vertical

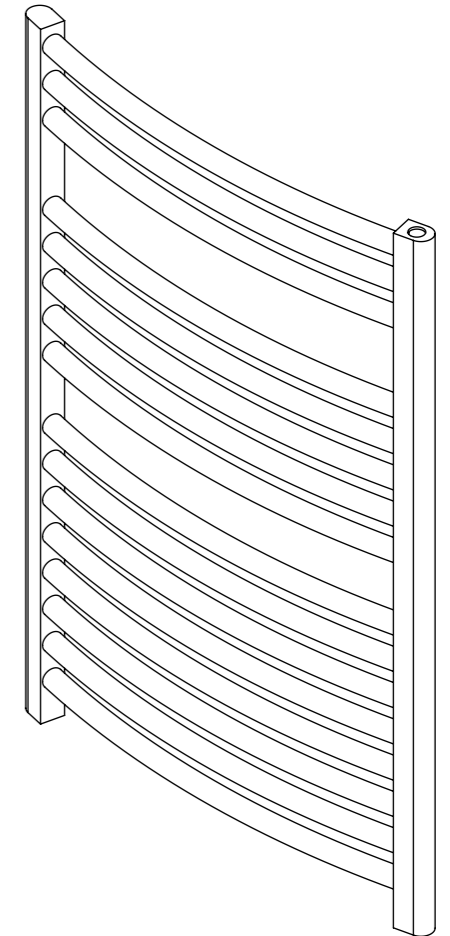
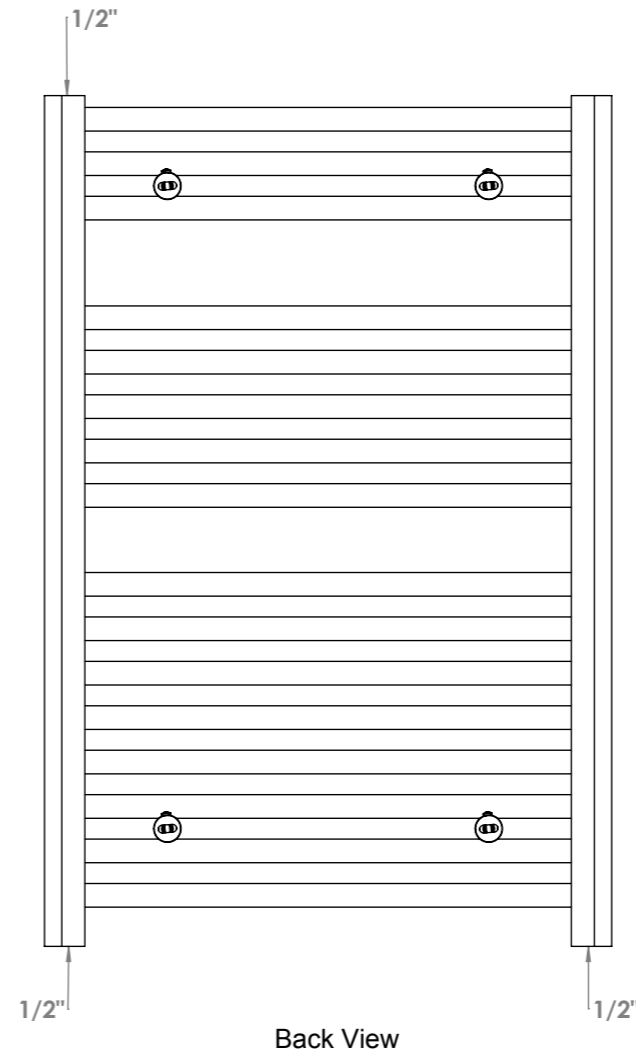
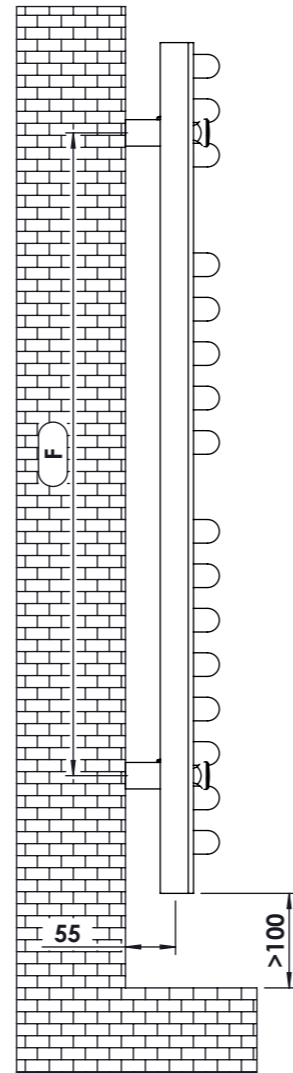
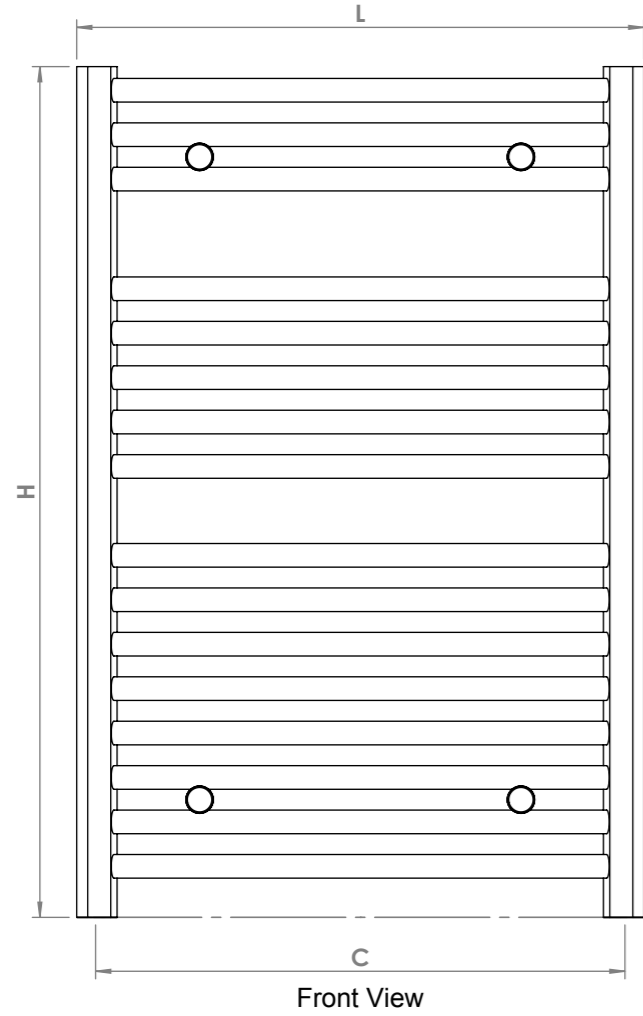
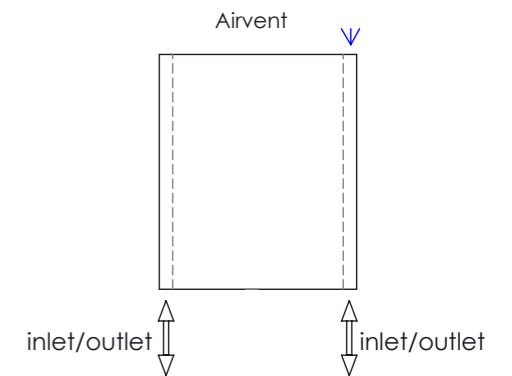

Installation Accessories:

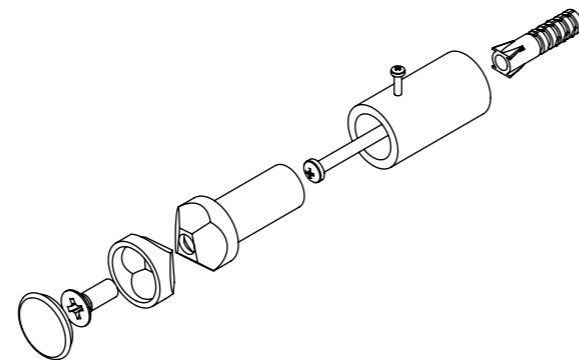
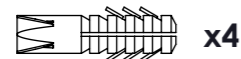
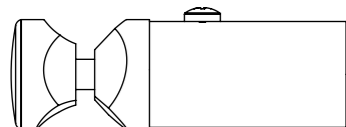

Vertical mount
 All Dimensions are in mm
 Max. Working Pressure: 10 Bar
 Max. Working Temperature: 95° C
 Inlet / Outlet : 1/2" BSP
 Fuel : E/H/D
 Ø25x1.2 mm Hor. Tubes
 30x40x1.5 mm Vert. Profiles

PRODUCT CODE	Height	Length	Depth	Pipe Centres	Bracket Centres	
	H mm	L mm	D mm	C mm	F mm	S mm
4MA9	900	420	55	380	680	340