

CHELMSFORD (3M12)

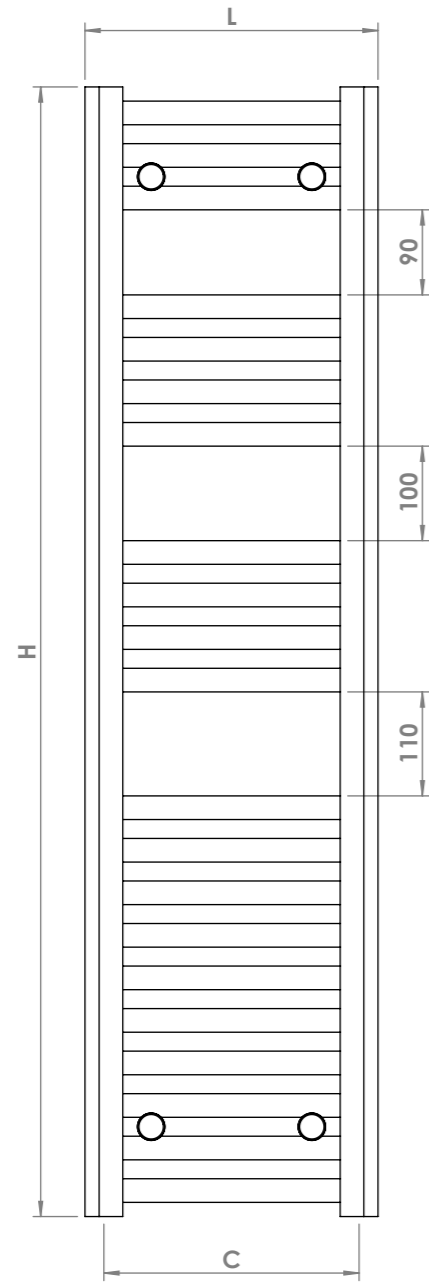

Front View

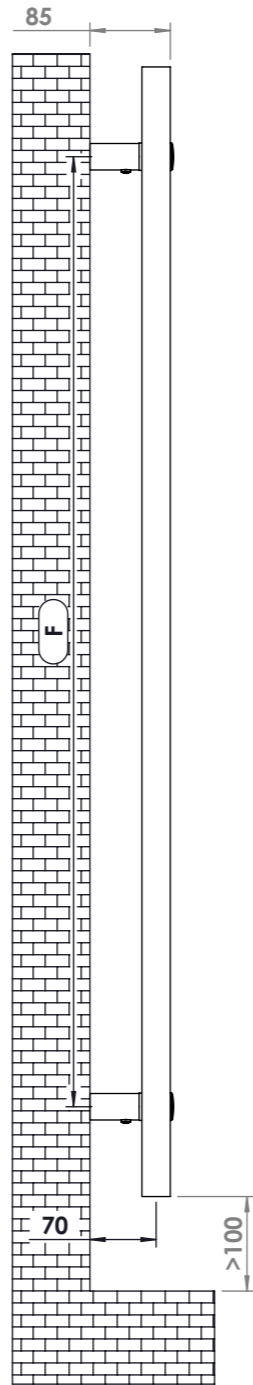

Side View

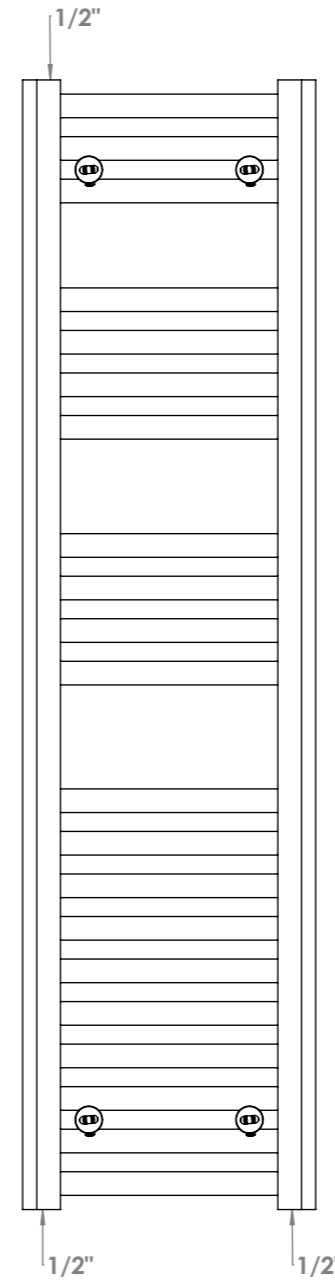

Back View

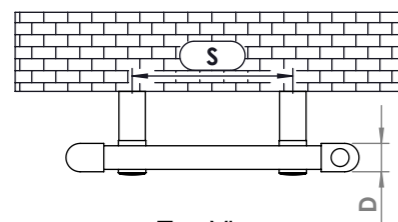
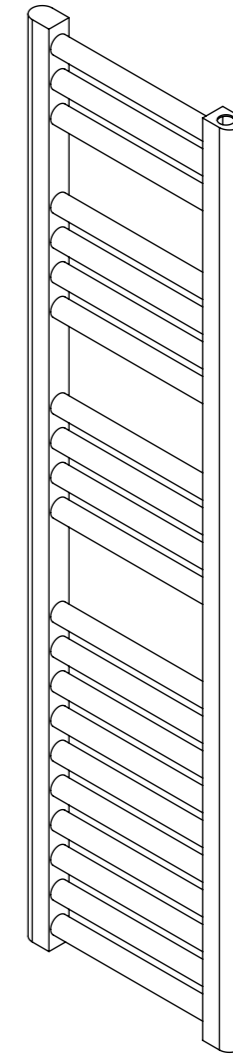

Top View

Plumbing Position: Vertical

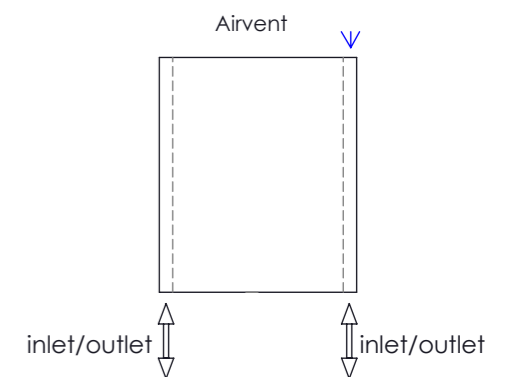

Installation Accessories:

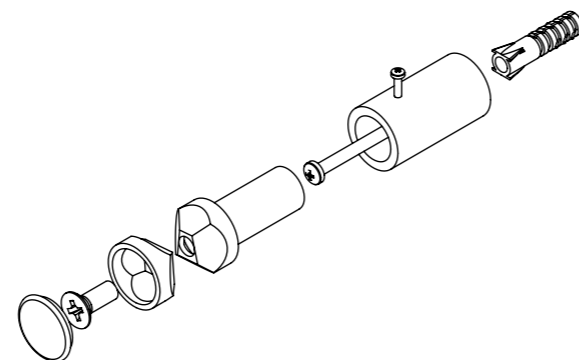
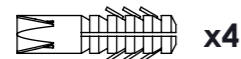
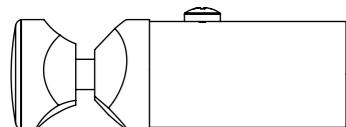

Vertical mount
 All Dimensions are in mm
 Max.Working Pressure: 10 Bar
 Max.Working Temperature: 95° C
 Inlet / Outlet : 1/2" BSP
 Fuel : E/H/D
 Ø25x1.2 mm Hor. Tubes
 30x40x1.5 mm Vert. Profiles

PRODUCT CODE	Height	Length	Depth	Pipe Centres	Bracket Centres	
	H mm	L mm	D mm	C mm	F mm	S mm
3M12	1195	310	30	270	1005	170